

# Data Sheet

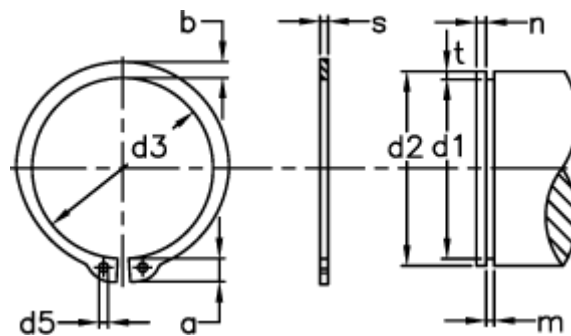

Article number: 0109051  
 Description: Retaining ring AS 34x2.5  
 Spring steel  
 Note: Fitted with ZGA pliers

## Measures



a max	= 6.6	Description	= AS 34	s	= 2.50
AN mm <sup>2</sup>	= 99.0	FN kN	= 16.40	t	= 0.85
B	= 2.78	FRg kN	= 15.6	tol	= -0.25
b	= 4.2	FR kN	= 87.0	tol	= -0.07
d1	= 32.3	g	= 1.5	tol	= +0,25 -0,50
d2	= 34	m min	= 2.65	Tong	= ZGA-3
d3	= 31.5	n abl x 1000	= 18	Weight kg/1000	= 6.80
d5 min	= 2.5	Nominal drive	= 2.8		